

OPERATIONAL AUTOMATIC VOLTAGE REGULATOR OF SHIP SYNCHRONOUS GENERATORS

Todor P. Lazarov, PhD

Hristo A. Milushev

Nikola Vaptsarov Naval Academy, 73, V. Drumev St., Varna 9026, Bulgaria

h.milushev@nvna.eu

Abstract

The paper presents a design of an automatic electronic voltage regulator of ship synchronous generators. It is intended to replace transistor regulators, which have low performance and accuracy parameters and their accuracy of voltage maintenance reaches 3 - 5 %. But this precision does not match the requirements.

The modeling of the valid regulator has a voluminous form. This creates lots of parasite capacitances and inductances, which affect its work speed. The old transistors often get out of order which reduces the reliability of the generator. In order to eliminate these disadvantages an automatic voltage regulator with operational amplifier was designed. Its main work principle is based on the comparison between the generator's voltage and the reference one. This difference is amplified and affects the control coil. If the generator's voltage differs from the standard, the quick impact on the coil restores it. The elements used in the regulator's production are modern with wide temperature range, high fidelity and fast operation. All this contributes to the elimination of the above mentioned defects.

Keywords: proportional-integral-differential controller, pulse-width modulation scheme, automatic voltage regulator, AVR, comparator

Introduction

Ship generators with automatic systems of excitation have to produce electricity in the needed quantity and relevant quality (Hebner 2005; Prousalidis 2008). It requires voltage and frequency

maintenance in the given parameters. According to the requirements of the ship registers the power system has to have the following characteristics.

In steady state the AVR must be able to keep the voltage within $\pm 2,5\%$ of the rated voltage under all steady load conditions. The limit can be increased to $\pm 3,5\%$ for emergency generator sets.

When specifying the requirements for voltage regulation in load changes, a definition of sudden load is used. The sudden load is defined to be more than 60% of the full load current at power factor of 0,4 lagging or less. When switching on the sudden load the instantaneous voltage drop must not exceed 15% of the rated voltage. When the load is switched off the voltage rise must not exceed 20%. In both cases the voltage regulation must restore the voltage within $\pm 3\%$ of the rated voltage within 1,5 s. For emergency generator sets not in parallel operation, the limits can be increased to $\pm 4\%$ and 5 s.

(Zalewska 2009) presents a comparative analysis of different types of voltage controllers for synchronous generators. For voltage regulation of generator control AVR employing conventional, fixed parameter compensators is able to provide good steady state voltage regulation and fast dynamic response to disturbances. Marine compound system is a typical example of a compound type of automatic voltage regulator of ship synchronous generator (Djagarov 1997).

Scheme of automatic voltage regulator

The basic AVR has to provide close-loop control of the synchronous generator (SG) terminal voltage by acting upon the exciter winding with a voltage, U . It may have 1,2,3 stabilization loops and additional inputs, besides the reference voltage U_{rvf} of SG and its measured value with load compensation U_c :

$$U_c = |U_g + (r_c + jX_c) \cdot I_g| \cdot \frac{1}{1+s\tau_s} \quad (1)$$

The load compensator introduces the compensation of generator voltage variation due to load and also the delay τ , due to the voltage sensor. Other than that, a major field-winding voltage U_f loop is introduced. The voltage regulator may be of many types (a lead-lag compensator, for example) with various limiters.

Block scheme of automatic voltage regulator is shown in fig. 1

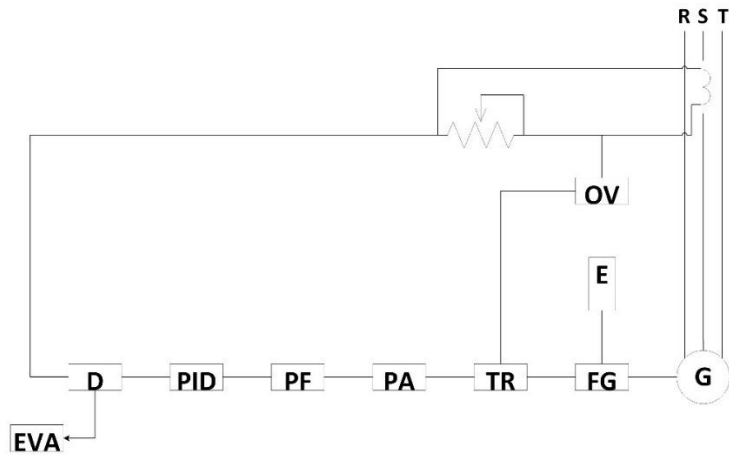

Fig. 1. Block Scheme of Automatic Voltage Regulator

Where: G – generator; FG – generator’s excitation coil; E – initial excitation; TR – thyristor; OV – Overvoltage protection; PA – pulse amplifier; PF – pulse phase; PID – proportional-integral-differential controller; D – measuring unit ΔU ; EVA – setting voltage reostat

An electrical scheme has been designed in order to meet the requirements of the Bulgarian Ship Register (fig. 2).

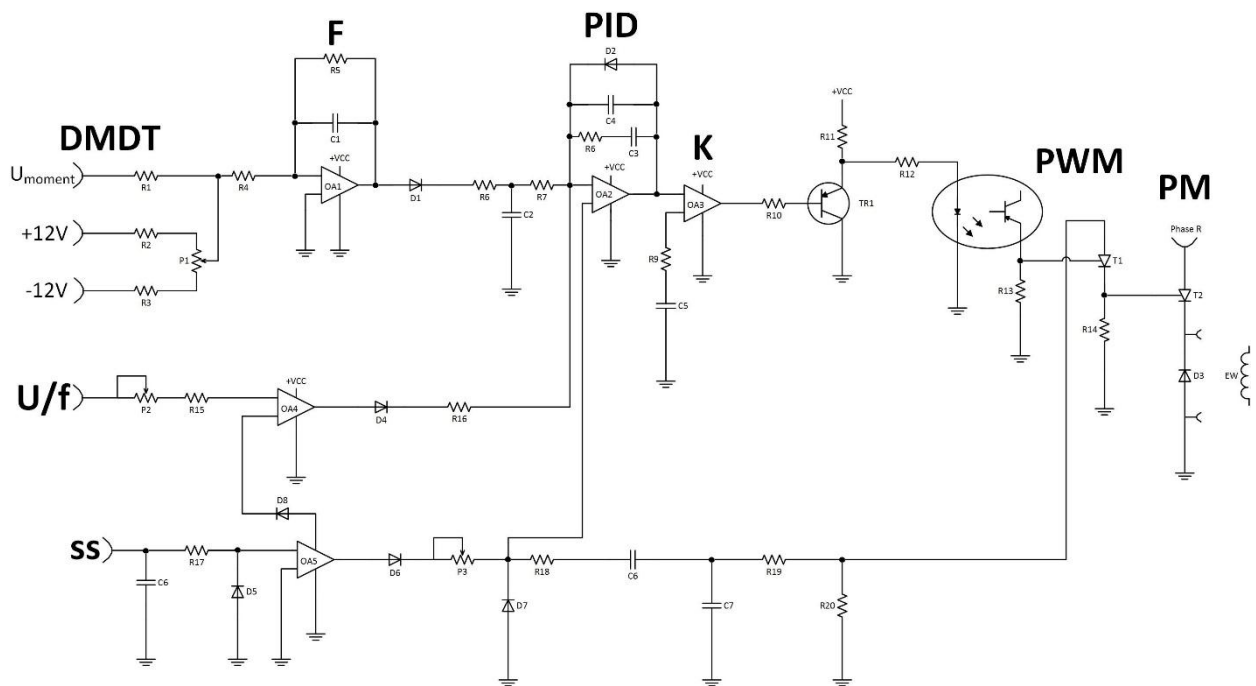

Fig. 2. Operational automatic voltage regulator of ship synchronous

On this scheme the following indications are shown:

DMDT – Device for measurement and droop tune; F - filter alerts; SS – synchronization scheme; PM – power module; PID – proportional-integral-differential controller; K – comparator; PWM – pulse-width modulation scheme operating the power module

Automatic voltage regulator measures the voltage of the generator and the change of the reactive current and regulates the voltage of excitation in a such way that the generator’s voltage is maintained in a state which is at least $\pm 2\%$ accurate as it ensures the static character at the reactive loading within the above-mentioned 2%. The automatic voltage regulator influences the generator’s voltage as it controls the generator’s excitation current. The regulator works on the base of the width-impulse principle as it regulates the width of the impulses towards the excitation coil and thus regulates the amount of the rotor current. The amount of the basic stabilized voltage, which is compared to the generator’s voltage, is changed by the means of the potentiometer P1 of DMDT.

In the device for measurement and droop tune (DMDT) the generator’s voltage U_g enters the automatic regulator and thus the unnecessary disturbances are filtered. The difference between the generator’s voltage U_g and the pilot voltage U_{ref} :

$$\Delta U = \pm (U_g - U_{ref}) \quad (2)$$

is sent to the PID controller.

It is processed in the PID controller and at the output a signal is produced, which controls PWM. At the other end, a voltage, which is proportional to the pilot voltage U_{ref} influences the rotor’s excitation coil.

Fig. 3 shows the dependence of the pilot voltage U_{ref} from the change of the generator’s voltage U_g .

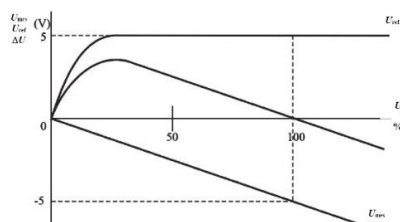

Fig.3. Graphic of the relations of the voltages

The three-phase voltage of the generator is transformed by a transformer and is stabilized by the power module, which ensures the supply of all modules of the automatic voltage regulator.

The comparator is an electronic scheme with analogue input and impulse output, i.e. the PID controller sends impulses with certain length and amplitude based on the input voltage to it. The output impulse indicates whether the input voltage U_g is bigger than the pilot voltage U_{ref} or not. This impulse operates the thyristors of the power module, which is shown in fig. 4.

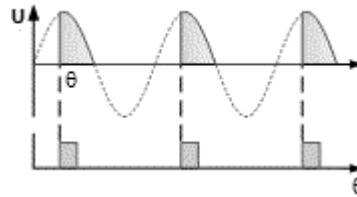

Fig. 4 Operation of the thyristor by the deviation of the voltage from the nominal one.

The main part is the operation amplifier, which ensures the work of the proportional-integral-differential (PID) controller. The deviation of the generator's voltage ΔU is amplified and this amplified difference ΔU is proportional to the integral of the entry voltage and it enters the comparator. PID controller and the pulse-width modulation scheme form the law of PID controlling according to which the voltage regulator functions and is presented by the formula:

$$U = k_p \cdot U_{mes} + \frac{1}{T_i} \cdot \int U_{mes} dt + T_d \cdot \frac{dU_{mes}}{dt} \quad (3)$$

Synchronization scheme (SS) is a functional generator, which sends impulses by the means of the comparator, which operates the pulse-width modulation scheme.

The electrical protection module U/f transfers impulses, which lock the power module at lower frequency of rotation of the generator up to 30 Hz, which results in the lower voltage supply to the excitation coil.

Investigation of the work of the automatic voltage regulator

The work of the designed automatic voltage regulator was investigated in Matlab environment. The system consists of synchronous generator with active-inductive load. The rated parameters of the generator are: $S = 5 \text{ kVA}$; $f = 50 \text{ Hz}$; $U = 390/235 \text{ V}$; $I = 7,4/4,5 \text{ A}$; $n = 3000 \text{ rpm}$; $U_f = 90 \text{ V}$; $I_f =$

3,8 A; $R_a = 1,5 \Omega$; $R_f = 18,2 \Omega$; $X_a = 8,5 mH$; $X_f = 518 mH$; $x_d' = 0,17 p.u.$; $x_d'' = 0,12 p.u.$.A short-circuit in the system is simulated at $t=4s$ and excluded by protection at $t=4.4s$.

The graphics look like:

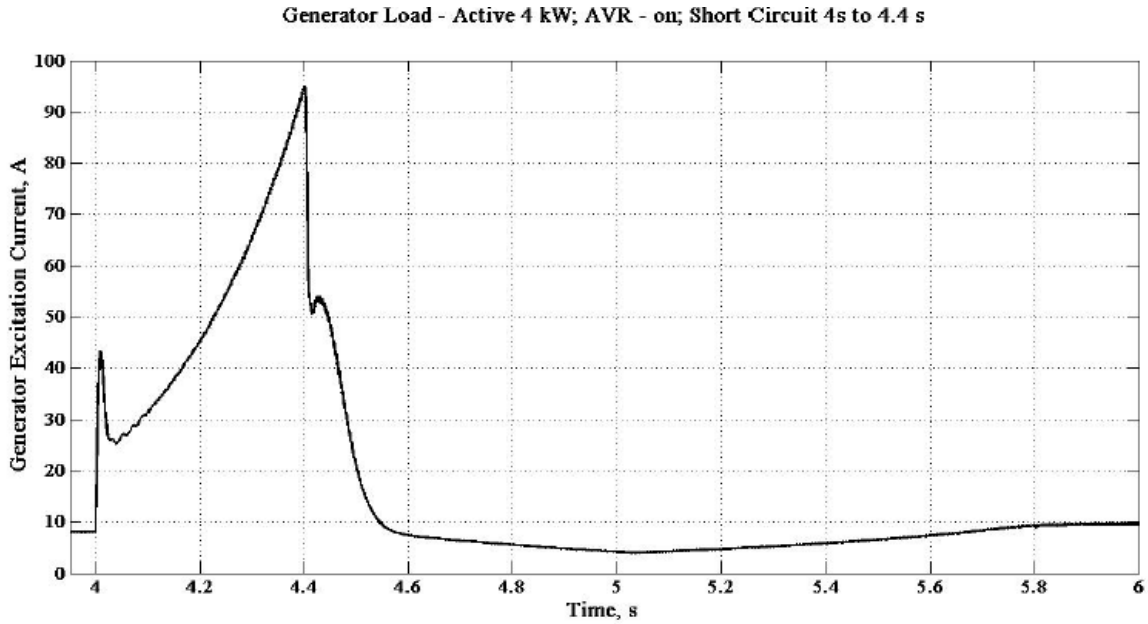

Fig. 5. Excitation current of the synchronous generator

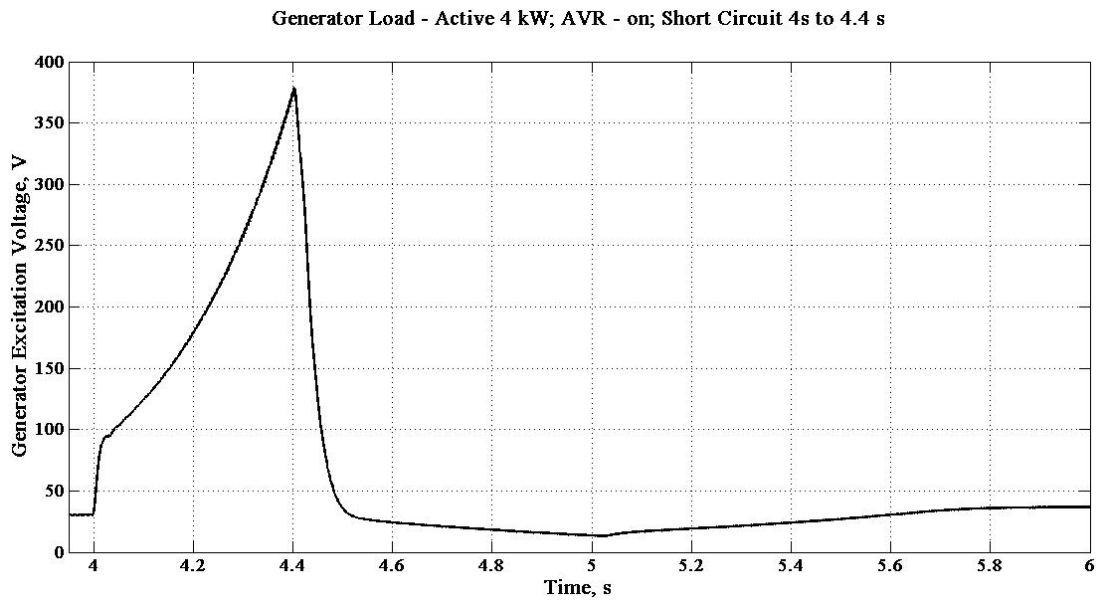

Fig. 6. Excitation voltage of the synchronous generator

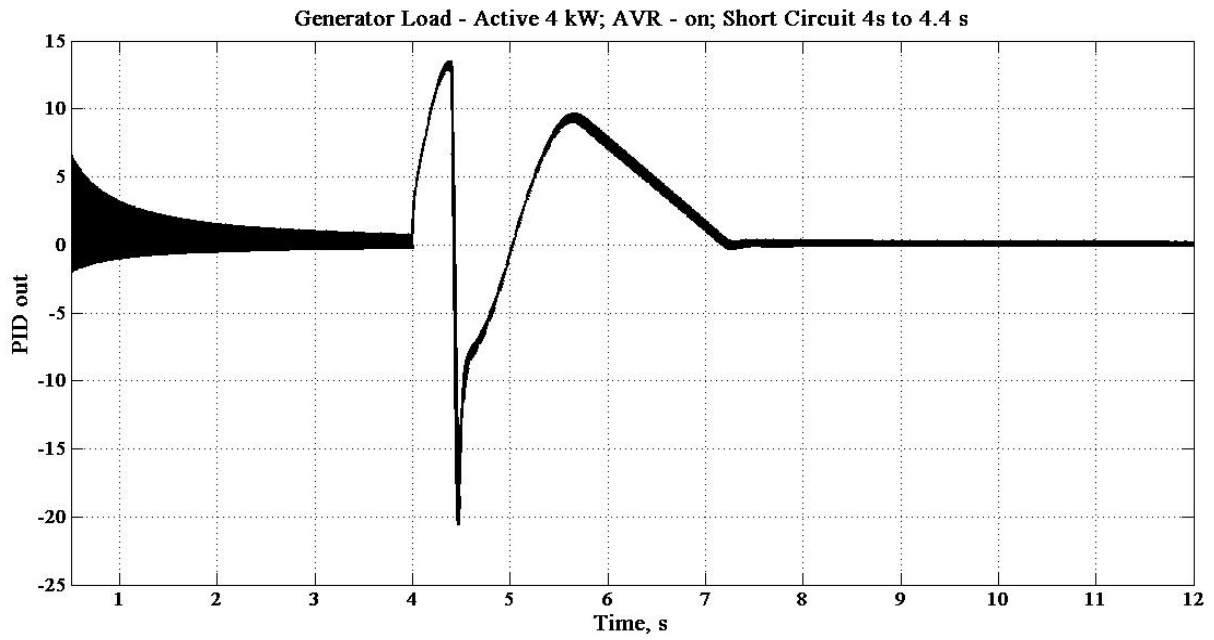

Fig. 7. Output signal from the PID controller

It can be seen from the graphs that the excitation current (Fig. 5) increases sharply, as a result, the excitation voltage is also increased (Fig.6). Fig. 7 shows that the generator's voltage drops, but due to the influence of the AVR on the generator excitation voltage, it is restored to the relevant parameters.

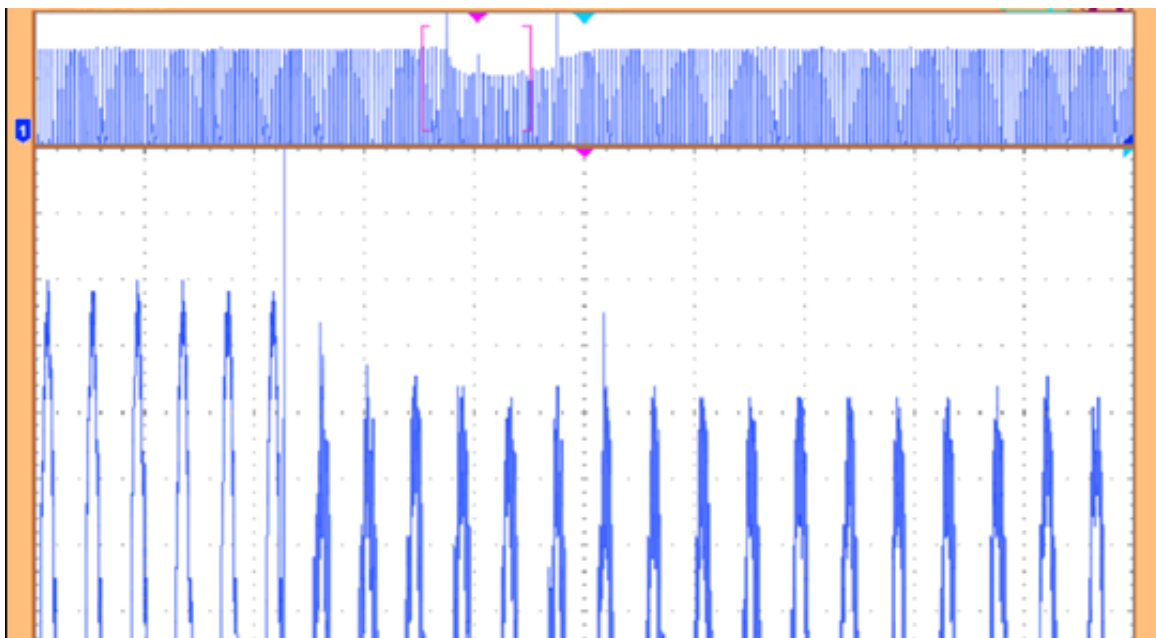

Fig. 8. Transient stator voltage of SG without AVR

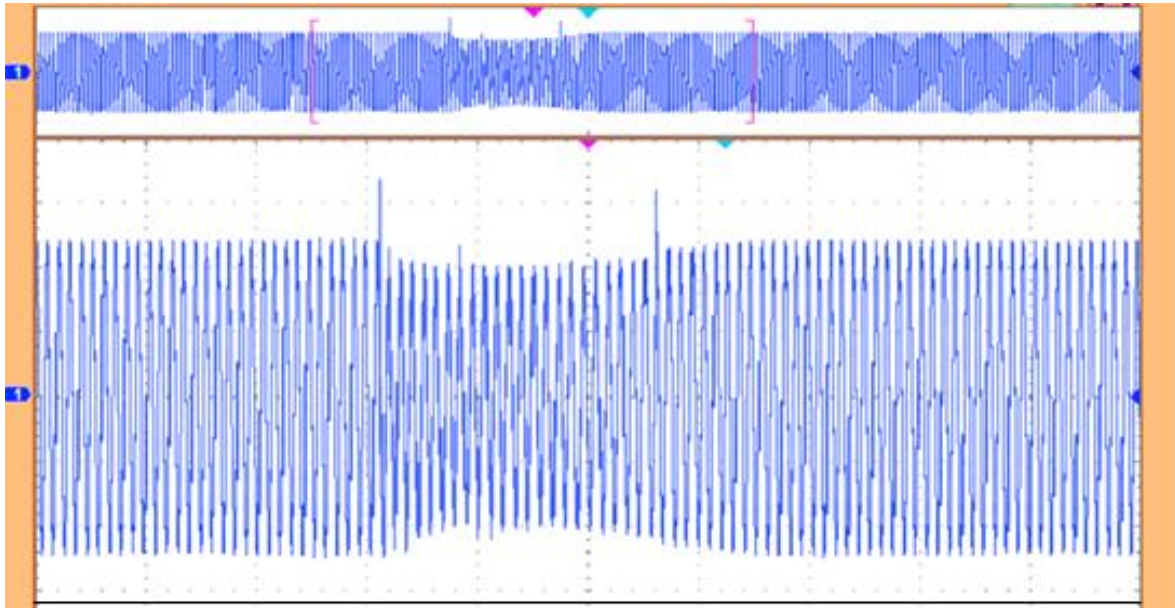

Fig. 9. Transient stator voltage of SG with AVR

On figures 8 and 9 is shown the transient stator voltage of the generator with and without AVR. It can be clearly seen that the stator voltage drop of the generator and the transient process duration in the simulation without AVR is much bigger than the same in the simulation with AVR.

Conclusion

The electronic automatic voltage regulator of ship's synchronous generators is used because of its high reliability and very good dynamic characteristics. The article describes the developed electronic automatic voltage regulator. The proportional-integral-differential regulator, which was developed, improves the static and dynamic characteristics of the generator. Graphics of simulation results of AVR are presented. They demonstrate the high accuracy of regulation of voltage of the ship's synchronous generator and the very good dynamic characteristics at various problematic circumstances.

References

HEBNER R. E., 2005. Electric Ship Power System – Research at the University of Texas at Austin, *IEEE Electric Ship Technologies Symposium IEEE ESTS 2005, 25-27 July 2005, Philadelphia, PA USA*.

J. PROUSALIDIS, E. STYVAKTAKIS, I.K. HATZILAU, F. KANELLOS, S. PERROS, E. SOFRAS, 2008. Electric power supply quality in ship systems: an overview, *International Journal Ocean Systems Management, Vol.1, No.1, pp.68-83*.

K. ZALEWSKA, W. REBIZANT AND R. KAWECKI, 2009. Comparative Analysis of Different Types of Generator Voltage Controllers, in *Proc. of the IEEE 44th Int. Universities Power Eng. Conf.*, UPEC, Sept. 1–4, pp. 1–4.

N. F. DJAGAROV, 1997. Korabni elektroenergiini sistemi [Ship's Electrical Power Systems], Technical University of Varna, pp. 42-47. [in Bulgarian].